



DOKK

Tailored ergonomics | Product catalogue 2024

www.dokk.store



Index

- 4 Why ergonomics
- 6 Standing desks
- 12 Desk features
- 14 Tabletops
- 16 Premium line tabletops
- 18 Conference & fixed desks
- 24 Chairs
- 32 Monitor arms & other solutions

Ergonomics: why it matters

Working while occupying unnatural body positions for an extended period of time is the main reason for the development of persistent pain. Statistically speaking, neck, back and wrist are the most commonly affected body regions for office workers. In fact, there is a higher chance of you developing pain, than avoiding it. And that is only where the real problem begins.

One in every four office workers, once experiencing it, will develop life-long pain episodes. Your actions regarding neck, back and wrist are the most important predictors for the onset and the duration of your pain.

Back pain is world's biggest pain problem causing the highest numbers of permanently reduced life quality. Prolonged sitting periods directly affect your health. Relationship seems to be exponential, with lower sitting time resulting in low risks, while sitting for more than six or eight hours per day increases the risks of heart-related and premature death.

Up to

63 %

**OF OFFICE WORKERS ARE DEALING
WITH NECK PAIN**

It is quite straight-forward, you have to lower the amount of time sitting. Even short periods of standing result in positive health outcomes.

The office-pain pandemic can stop with you. Shop the perfect solutions, allowing you to seamlessly shift between sitting and standing without compromising your productivity.



Standing Desks

M2

Height	60 - 125 cm
Max. load	120 kg
Lifting speed	38 mm/s



Health shaker. Difference maker.

Supercharge yourself through the day and take your productivity on the next level. With two reliable motors the Model Two delivers a height change of 65 centimetres in the matter of seconds. Combined with the stunning Riser, Alcantara Desk Mat and all the accessories you need, it will help you shake up your office routine and feel the difference.



M2 Round

Height	64 - 129 cm
Max. load	120 kg
Lifting speed	38 mm/s



M2 Ellipse

Height	64 - 129 cm
Max. load	120 kg
Lifting speed	38 mm/s



M3

Height	60 - 125 cm
Max. load	150 kg
Lifting speed	38 mm/s
Angles	90° / 120° / 180°

**B4 Round**

Height	64 - 129 cm
Max. load	200 kg (100 kg each)
Lifting speed	38 mm/s

**B4**

Height	60 - 125 cm
Max. load	200 kg (100 kg each)
Lifting speed	38 mm/s

**B4 Ellipse**

Height	64 - 129 cm
Max. load	200 kg (100 kg each)
Lifting speed	38 mm/s



All the lifting mechanisms are tested on 42.000 cycles.

Features that make it even better



Provider

Power at arms reach.

3x schuko
1x usb-a
1x usb c



Slider

Storage right where you need it.

21x26 cm storage drawer.



Privacy panel

Privacy in the office made simple.

Available in multiple colours.



Cable management

Get's rid of all the clutter.



Wheels

If you like to move.



Tabletops



Trend line

Wide selection of different colors, which will adapt to even the most demanding space.

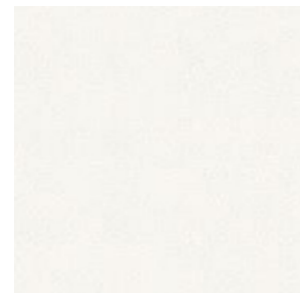

White
D129 PS11 18/25 mm



Gray
D123 PS30 18/25 mm



Anthracite
D143 PS14 18 mm

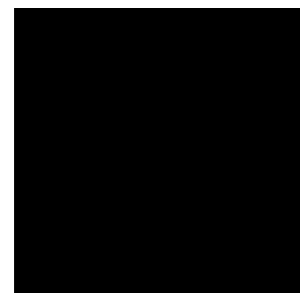

Black
D701 PS14 18/25 mm



Azurite
D181 PS13 18mm



Pastele Yellow
D173 PS13 18 mm



Magnolia
2507 BS 25 mm



Basalt
D165 PS11 18 mm



Oak Endgrain
K5414 25 mm



Maple
A319 PS17 18/25 mm

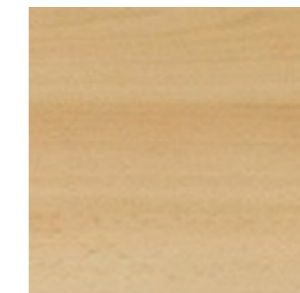

Light Beech
A802 PS17 18/25 mm

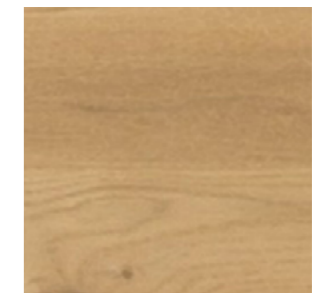

Oak Corona
A860 PS13 18 mm



Oak Sonoma
34038 AT 25 mm



Oak Sherwood
A865 PS19 18/25 mm

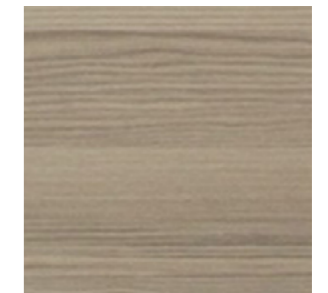

Cordoba
A395 PS19 18/25 mm

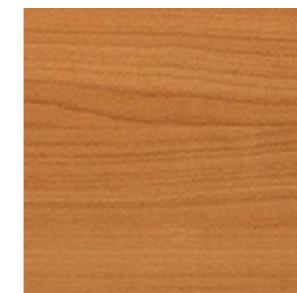

Cherry Oxford
K801 PS11 18/25 mm



Oak Sonoma Dark
A866 PS19 18/25 mm

Premium line

Masive wood that personifies quality and sustainability.



Oak
Slovenian oak - oil stained
Thickness 27mm.



Blok
Oak butchers block - oil stained
Thickness 27 mm.



Walnut
Slovenian walnut - oil stained
Thickness 40 mm.

Premium line edge options

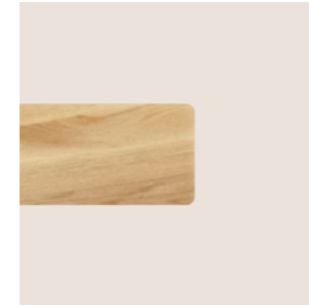

Straight Edge
Traditional straight edge. Rigid, elegant and timeless.



Swiss Edge
Beveled at negative 45 degrees. Makes the table look slimmer and lighter.

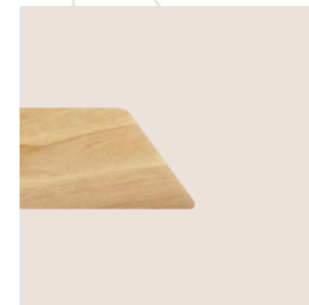

Soft Edge
Beveled at 45 degrees. Made for more comfort. Makes resting your hand on the edge feel more comfortable.



Live Edge
Elevates the table and gives it more of a live and natural feel.

Conference and fixed desks



FH4



FH4 Round



FH4 Round



FH6



FH6 Round



FC4



FI4



FI4 Round



FC4



FS2



FB1



FT1



FS4



Ergonomic Chairs



S1 Pro

Seat height	46 - 55 cm
Seat depth	43.5 - 46 cm
Recline angle	100° - 130°
Max. load	136 kg



Flexible lumbar support



Two separate pads, offering comprehensive and dynamic support for your lower back.

Seat depth adjustment



The upper half of the backrest can be adjusted separately in 5 levels, providing adequate support to your shoulders and neck.

Anti-Gravity mechanism



Effectively absorbs shock when you sit down on the chair and dynamically adjusts to changes in your seating position.

S1

Seat height 44 - 52 cm
 Seat depth 38.5 - 43.5 cm
 Recline angle 100° - 130°
 Max. load 136 kg



Dual dynamic lumbar support



Independent backrest



4D adjustable armrest



Premium elastic mesh



Seat depth adjustment

S3 Pro

Seat height 46 - 56.7 cm
 Seat depth 42.7 - 45.1 cm
 Recline angle 105° / 120° / 135°
 Max. load 136 kg



Dynamic lumbar support



Flexible backrest



6D adjustable armrest



Premium elastic mesh



Seat depth adjustment



Y1



L8



Y1W



M77



Y7



S1C





R22



R21



R26



Other solutions



A1R



HW1



HW2



HW3

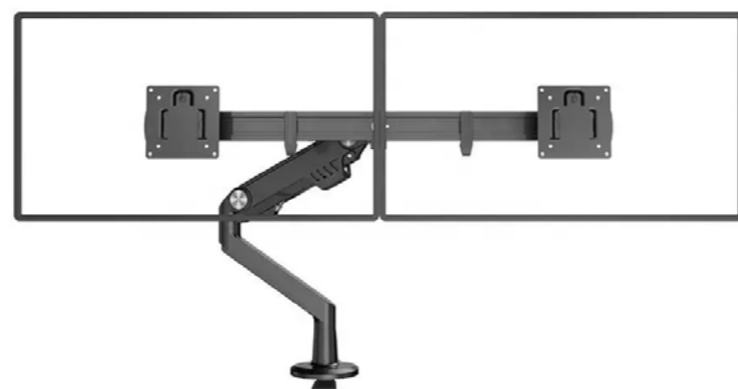

D1



C1

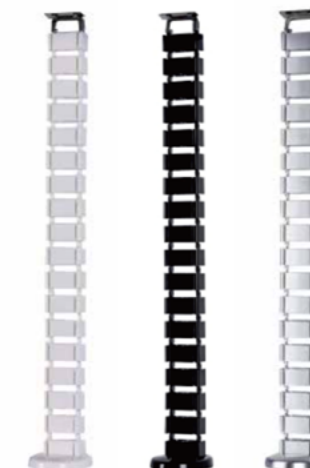

**R1**

Height 20 / 27 cm

Top dimensions 23 x 22 cm

Base material *Premium wood options***A1**

Height 8 / 14 cm

Top dimensions 50 x 21 cm

**D2**

Height 8 / 14 cm

Dimensions 60 / 90 x 17 / 25 cm

Shelf colour *Same as tabletops*

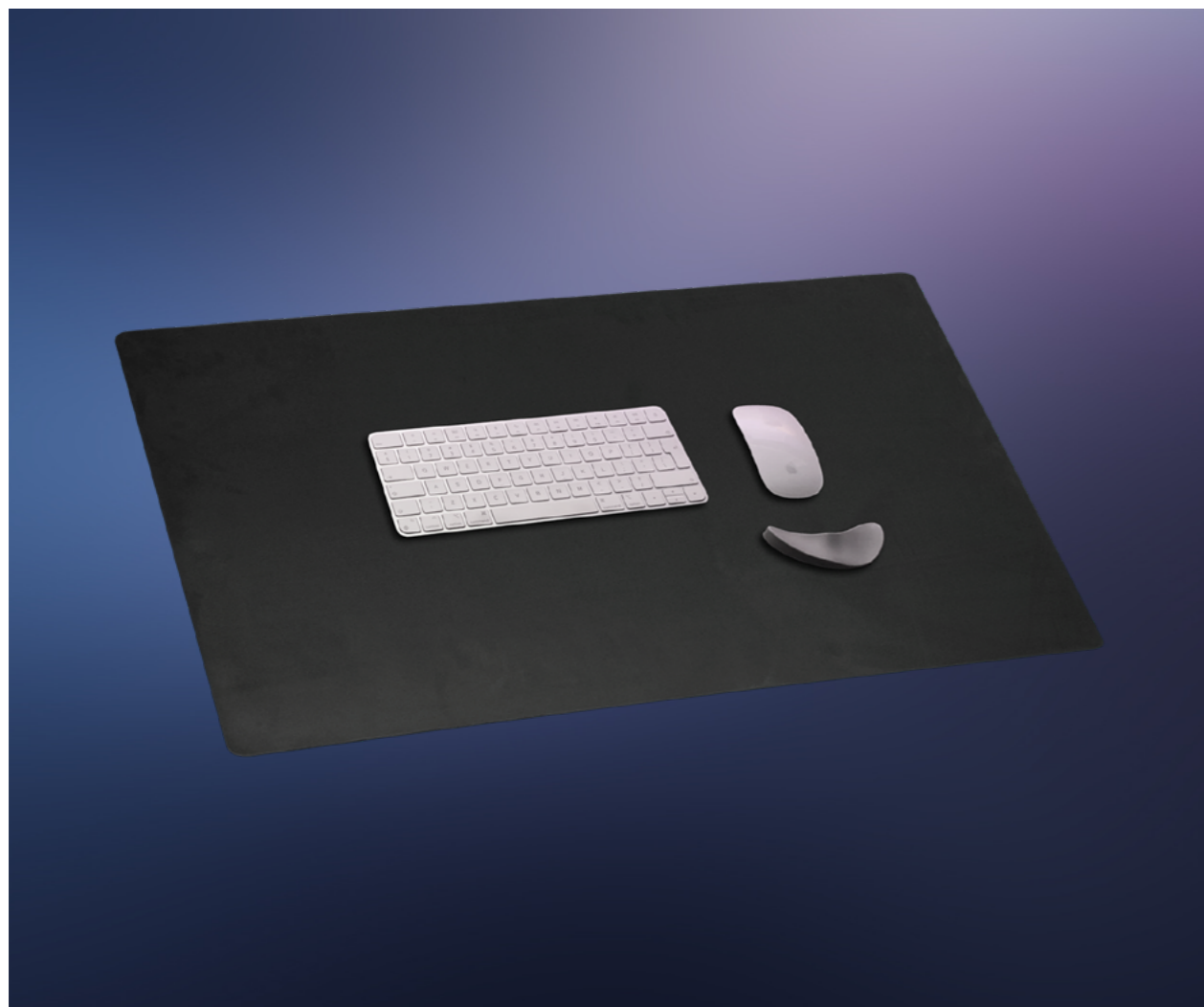
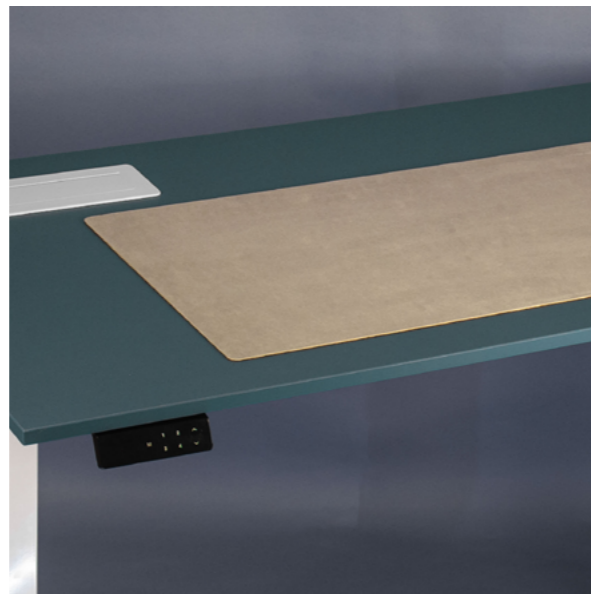
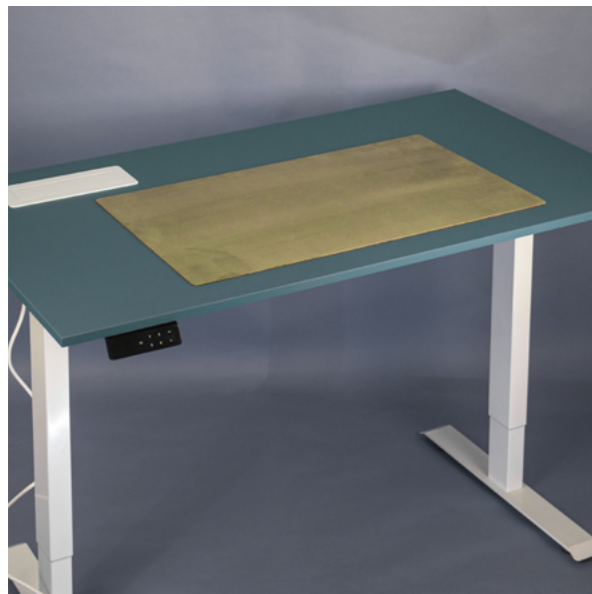

Alcantara Desk Mat



W Pad



Desk Mat

Large	80x40 cm
Medium	60x30 cm
Small	30x25 cm



Y20

Height	20 / 34 cm
Dimensions	26 x 42 cm





DOKK

Tailored Ergonomics.
www.dokk.store

info@dokk.store

Katalog je informativne narave. Pridržujemo si pravico do sprememb.
Slike se lahko nekoliko razlikujejo od dejanskega videza izdelka.

Za vse izdelke velja dvoletna garancija in trajna servisna podpora. Možnost podaljšanja garancije.
Morebitne pritožbe bomo obravnavali kot odgovoren prodajalec. Reklamacijam bomo ugodili po najboljši možni meri. Čas in način dobave bo z naročnikom dogovorjen pred zaključkom naročila. Ob potrditvi naročila prične veljati takrat definirana ponudba, ki do zaključka kupoprodajne pogodbe velja za ponudnika in naročnika.

Dokk, prilagojene rešitve, Marin Štefanec s.p., Ribiška pot 42, 2230 Lenart v Slov. goricah, Slovenija